

AQUATECH SCIENTIFIC INSTRUMENTS

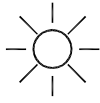

ASI

# DBX2 MANUAL

PRECISION PRESSURE INDICATOR

FIRMWARE VERSION 1.35

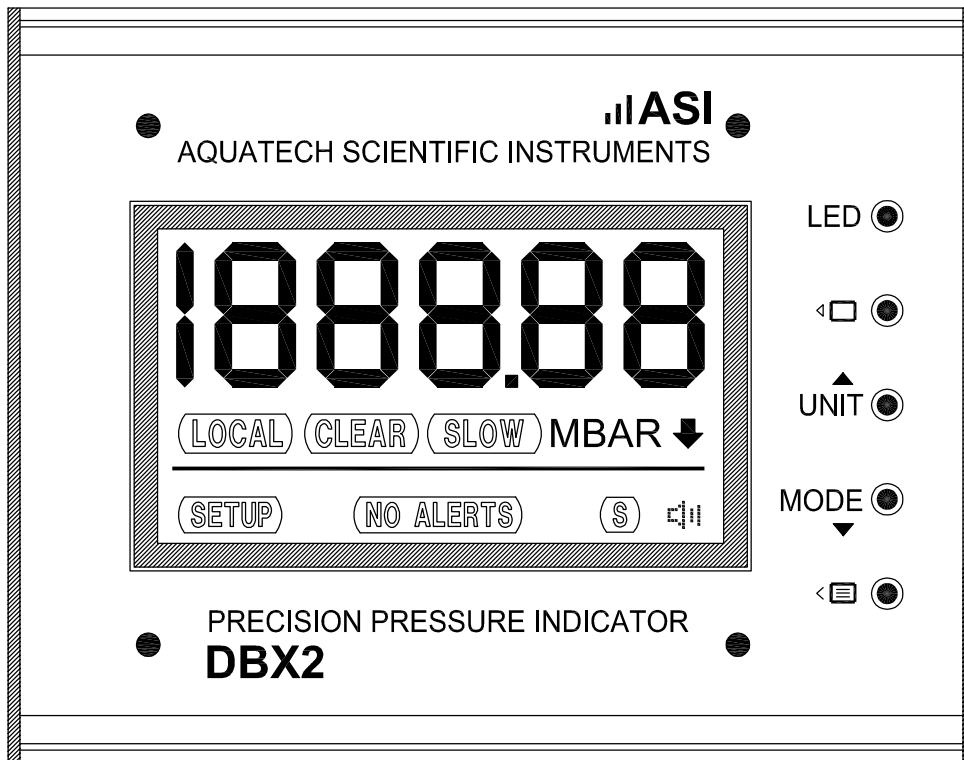

MULTI-FORMAT INSTRUMENT  
WITH PRESSURE GRAPHING

Multi Format

Graphing

Forecasting

Audible Alerts

REV 1.0

---

# INTRODUCTION

THANK YOU FOR PURCHASING THE DBX2 PRECISION DIGITAL BAROGRAPH.

Please read through this entire manual to become familiar with this unit's functions. If you have any questions, please contact us. \*See page 14 for contact information.

The DBX2 is a precision digital barometer. The DBX2's intended use is to detect changes in atmospheric pressure. No other use is described.

AQUATECH SCIENTIFIC INSTRUMENTS LLC (ASI) has had an outside independent laboratory test a sample set of our units for accuracy. (ASI) in no event will be liable for direct, indirect, special, incidental or consequential damages resulting from a defect in the unit.

No part of this manual may be reproduced in any form, or by any means, without permission in writing from (ASI), except for your personal use with this product.

All rights reserved.

Copyright 2017 by AQUATECH SCIENTIFIC INSTRUMENTS LLC

See warranty information on page 14 of this manual.

## Table of contents

Introduction.....	1
Unit overview.....	2
Display overview.....	3
Control overview.....	4
Unit setup.....	5
Setup your unit for Sea level Pressure.....	6
System Setup.....	7
Interpreting the pressure graphs.....	8
Terms and Definitions.....	9
Unit specifications.....	10
Wiring harness information.....	11
Accessories.....	12
Trouble shooting and FAQ.....	13
Warranty and contact information.....	14

# DBX2 UNPACKING AND UNIT OVERVIEW

1. Unpack the DBX2 Digital Barograph and accessories.
2. Plug the DBX2 in with the provided AC/DC wall adapter.
3. Read through instructions and set your elevation.

IMPORTANT: FORECASTS AND WARNINGS ARE BASED ON YOUR SEA LEVEL PRESSURE AND CORRECT ELEVATION.

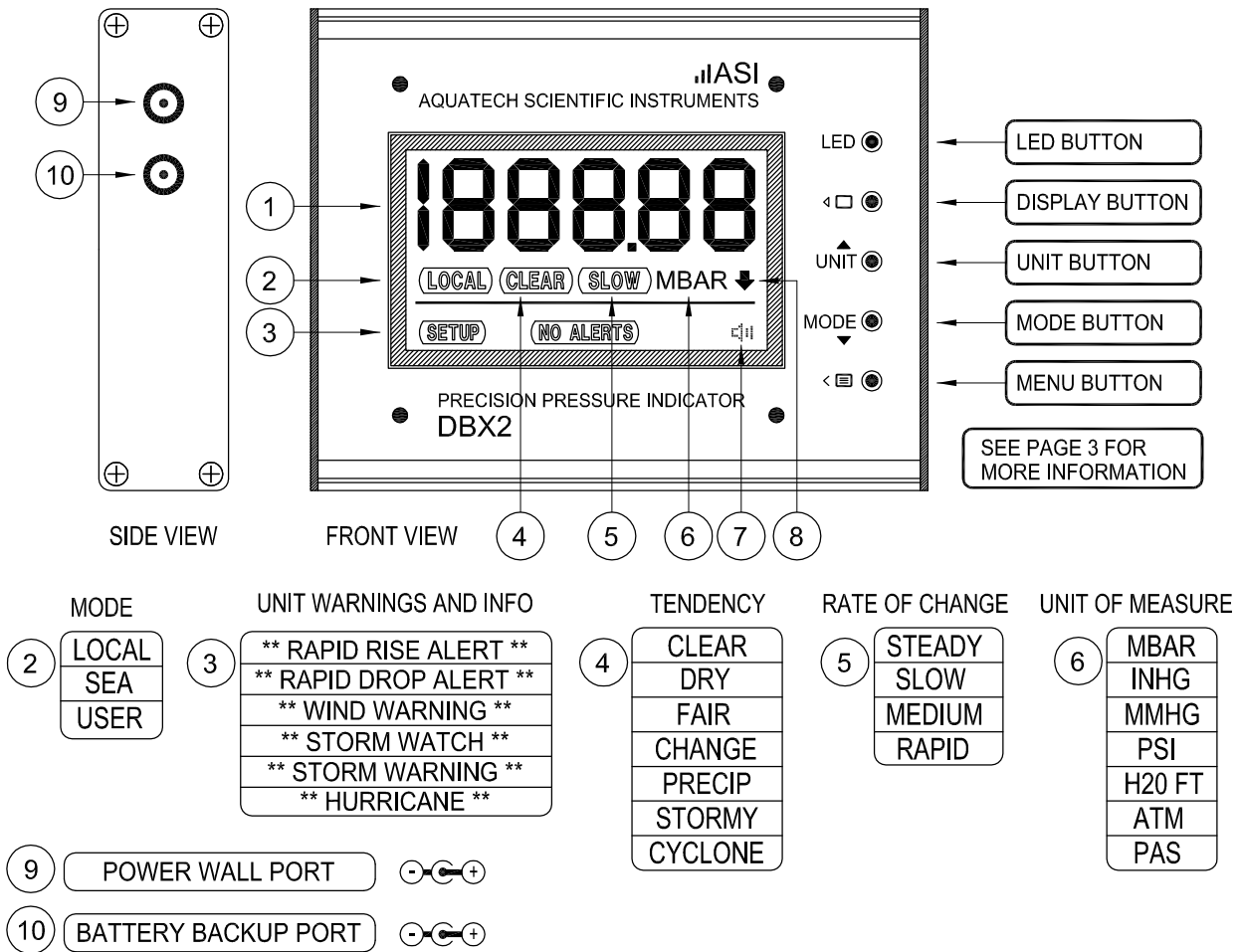

1. EASY TO READ - LARGE TEXT FORMAT DISPLAY.
2. CURRENT MODE: ( LOCAL, SEA, USER )
3. MESSAGE & WARNING AREA. SHOWS SEQUENCE MODE, THRESHOLD ALERT, SPEAKER ICON.
4. CURRENT TENDENCY.
5. CURRENT RISE OR DROP RATE: ( STEADY, SLOW, MEDIUM, RAPID )
6. CURRENT UNIT OF MEASURE: ( MBAR, INHG, MMHG, PSI, H20 FT, ATM, PAS )
7. CURRENT AUDIBLE ALERT STATE: ( ON/OFF )
8. CURRENT PRESSURE DIRECTION INDICATOR: ( RISE, DROP, STEADY )

## POWER CONSUMPTION:

20.0 mA @ 5.0 volts in standard operation mode.

100.0 mA @ 5.0 volts in standard operation mode with LED backlight on.

# ASI DBX2 DISPLAY OVERVIEW

SCREEN 1 (MAIN SCREEN)

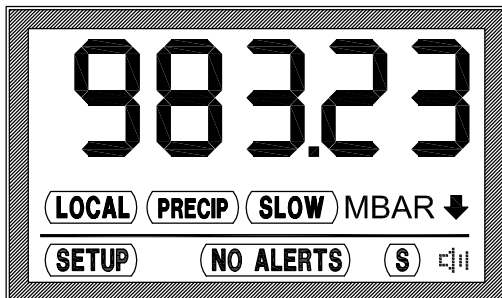

SCREEN 4 (ALL FORMATS REAL TIME)

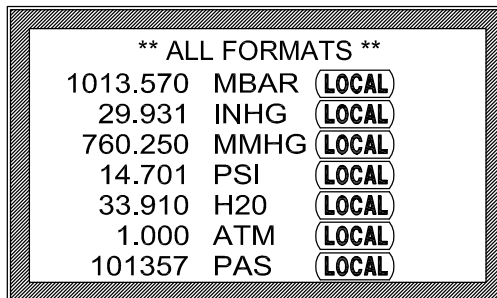

SCREEN 2 (ONE DAY GRAPH)

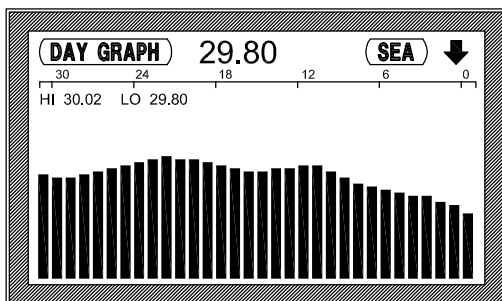

SCREEN 5 (SEA STATS)

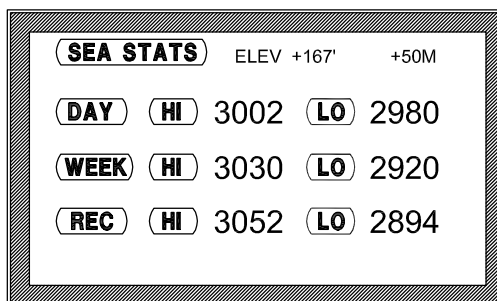

SCREEN 3 (ONE WEEK GRAPH)

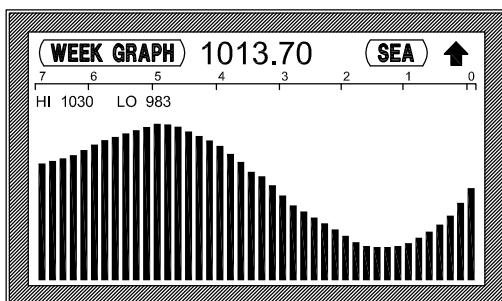

SCREEN 6 (USER SETTINGS)

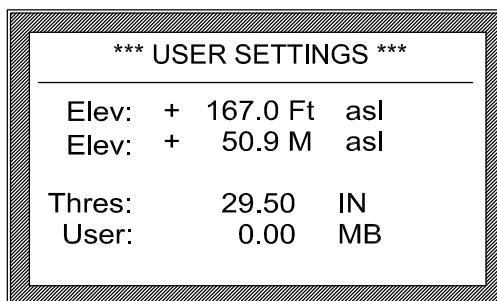

SCREEN 7 (UNIT INFORMATION)

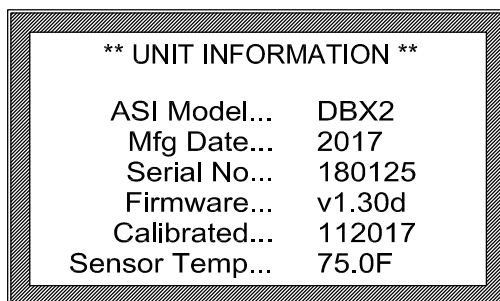

USE THE DISPLAY  BUTTON TO SWITCH BETWEEN THE 7 DISPLAY SCREENS.

YOU CAN ALSO SET AUTO-SEQUENCE UNDER PREFERENCES TO SEQUENCE BETWEEN THE MAIN SCREEN, 1 DAY GRAPH AND 1 WEEK GRAPH AND SEA STATS EVERY 7 SECONDS. YOU CAN TURN THIS FEATURE OFF BY TURNING OFF/ON THE BACKLITE OR CHANGING THE SETTING IN PREFERENCES.

YOU CAN CHANGE THE UNIT TYPE OR MODE ANYTIME IN NORMAL OPERATING MODE.

YOU CAN SHOW OR DISSABLE HI AND LO PRESSURES ON THE GRAPH SCREENS BY SETTING GRAPHDAT UNDER PREFERENCES. DEFAULT IS ON.

# DBX2 CONTROL OVERVIEW

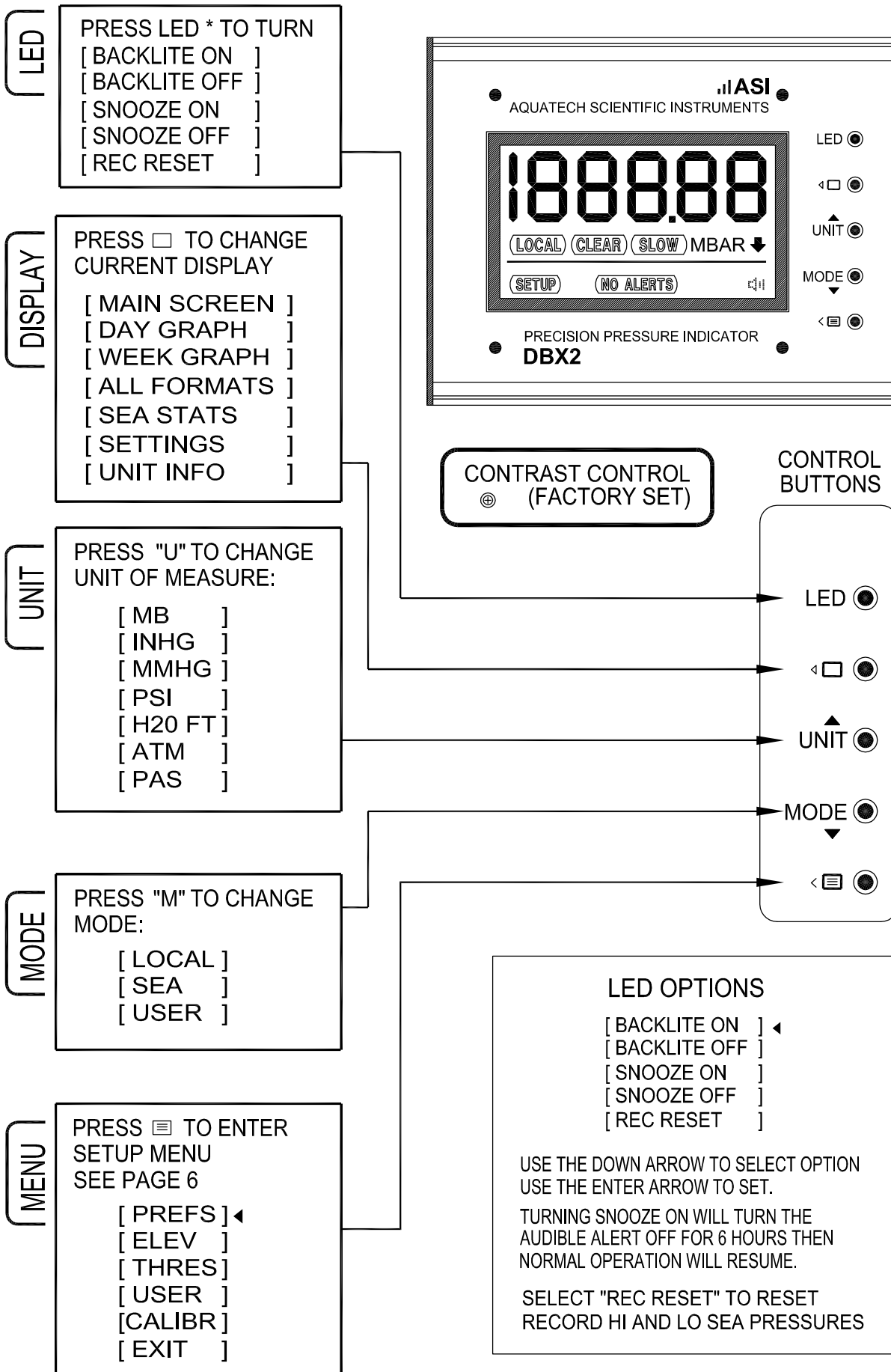

---

# DBX2 UNIT SETUP

## **SEA LEVEL PRESSURE (SEA)**

Barometers are usually setup for SEA level pressure. SEA level pressure is the actual LOCAL air pressure at your elevation, plus the additional air pressure below your elevation down to sea level. All world pressure maps use this format. By adjusting your pressure to SEA level, you can easily compare your pressure reading with other locations around the world. The DBX2 uses an ELEVATION value to adjust the SEA level pressure.

THE SEA PRESSURE CALCULATION IS BASED ON THE FORMULA THAT THE FAA USES TO CALCULATE QNH:

$$QNH = (\text{LOCAL\_PRESSURE}^{0.1903} + 0.00001313 * Z)^{(1/0.1903)}$$

IMPORTANT: FORECASTS AND WARNINGS ARE BASED ON YOUR SEA LEVEL PRESSURE AND CORRECT ELEVATION.

## **LOCAL PRESSURE (LOCAL)**

The LOCAL pressure is the actual air pressure at your elevation. The DBX2 is calibrated to read the actual LOCAL pressure. Local pressure is generally used in the research, automotive, medical fields, testing laboratories, manufacturing, etc.

## **USER PRESSURE (USER)**

The DBX2 makes it easy to offset the local pressure to a user determined value. Once set the user pressure will be the local pressure plus the user offset and will be displayed when MODE is set to USER.

## **THRESHOLD ALERT** (T)

The Threshold alert allows the user to set a pre-determined pressure that when reached will signal an audible and visual alarm. To clear alerts see display options on page 9.

## **DBX2 GRAPHS** (DAY GRAPH) (WEEK GRAPH)

When first setup the 1-Day and 1-Week graph will show only one bar on the right side of the screen. The 1 day graph will add a bar every hour and the 1-Week graph will add a bar every 4 hours.

# SEA LEVEL PRESSURE

## HOW TO SET YOUR SEA LEVEL PRESSURE

To set your SEA LEVEL PRESSURE you only need to know your elevation above sea level. You can determine your elevation through a mobile phone with GPS capabilities or you can use a program such as google earth to pin down your elevation. Then simply enter this elevation as FEET in the DBX2 setup.

IMPORTANT: FORECASTS AND WARNINGS ARE BASED ON YOUR SEA LEVEL PRESSURE AND CORRECT ELEVATION.

Your unit can display 21 different pressure formats by pressing:

**UNIT**

PRESS "U" TO CHANGE UNIT OF MEASURE:

- [ MB ]
- [ INHG ]
- [ MMHG ]
- [ PSI ]
- [ H2O FT ]
- [ ATM ]
- [ PAS ]

**MODE**

PRESS "M" TO CHANGE MODE:

- [ LOCAL ]
- [ SEA ]
- [ USER ]

MOST USERS WILL USE "SEA" PRESSURE

TOP OF ATMOSPHERE

$$QNH = (\text{LOCAL\_PRESSURE}^{0.1903} + 0.00001313 * Z)^{(1/0.1903)}$$

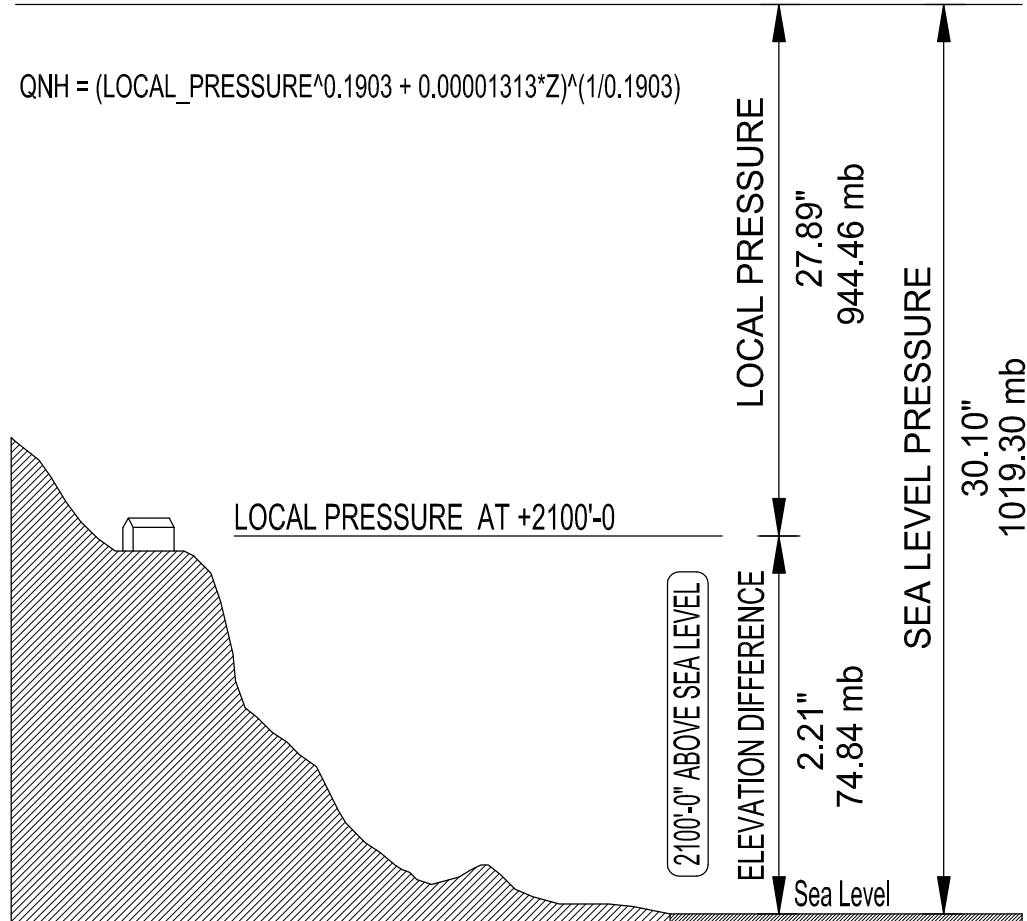

# DBX2 SYSTEM SETUP

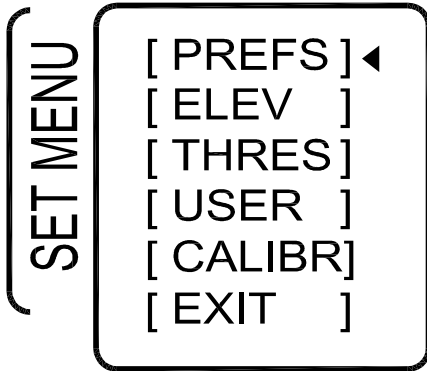

USE THE UP/DOWN  $\blacklozenge$  BUTTONS TO SELECT 1 OF THE 5 OPTIONS.  
THEN PRESS THE ENTER  $\blacksquare$  BUTTON TO ENTER THAT SETUP ITEM.

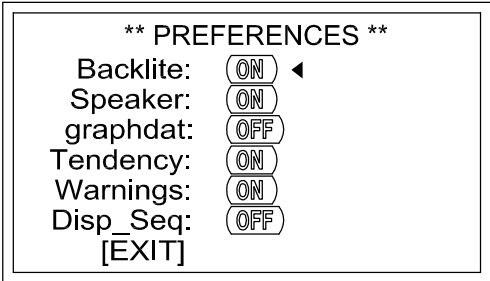

(PREFERENCES)  
USE THE UP/DOWN  $\blacklozenge$  BUTTONS TO SELECT AN OPTION.  
PRESS THE MENU  $\blacksquare$  BUTTON TO TOGGLE OPTION ON / OFF.  
SCROLL TO EXIT AND PRESS THE MENU  $\blacksquare$  BUTTON TO EXIT.

( ENABLE ) graphdat to show HI and LO pressure data on the graph screens.  
( ENABLE ) Disp\_Seq to turn on display sequencing - rotates screens every 7 seconds.

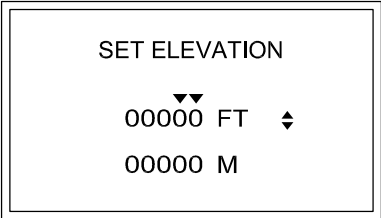

(ELEVATION)  
USE THE UP/DOWN  $\blacklozenge$  BUTTONS TO INCREASE OR DECREASE VALUE.  
USE THE  $\square$  BUTTON TO SWITCH FIELDS (LEFT AND RIGHT)  
PRESS THE MENU  $\blacksquare$  BUTTON TO SET VALUE AND EXIT.

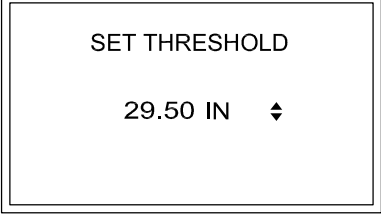

(THRESHOLD)  
USE THE UP/DOWN  $\blacklozenge$  BUTTONS TO INCREASE OR DECREASE THE FIELD VALUE.  
PRESS THE MENU  $\blacksquare$  BUTTON TO SET VALUE AND EXIT.

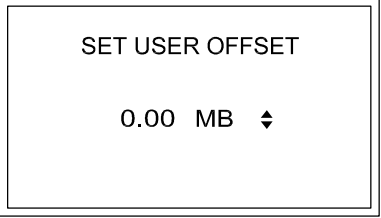

(USER)  
USE THE UP/DOWN  $\blacklozenge$  BUTTONS TO INCREASE OR DECREASE THE FIELD VALUE.  
PRESS THE MENU  $\blacksquare$  BUTTON TO SET VALUE AND EXIT.

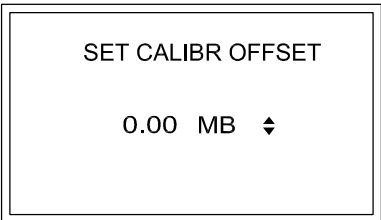

(UNIT CALIBRATION)  
USE THE UP/DOWN  $\blacklozenge$  BUTTONS TO INCREASE OR DECREASE THE FIELD VALUE.  
PRESS THE MENU  $\blacksquare$  BUTTON TO SET VALUE AND EXIT.

\*\* YOU CAN SEE THESE SET VALUES ON THE UNIT SETTINGS SCREEN  
\*\* SEE IMPORTANT NOTES ABOUT EACH SETTING ON PAGE 9.



# DBX2 - GRAPHS AND WEATHER FORECASTING

## 1 DAY GRAPH ( 32 HOURLY RECORDS )

PRESSURE HAS BEEN DROPPING FOR LAST 6 HOURS

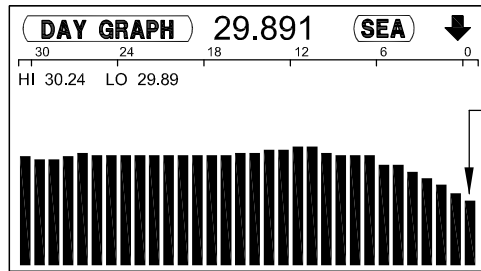

(DETERIORATING WEATHER CONDITIONS)

	<b>CURRENT READING</b>
	POSSIBLE STORM OR PRECIP. APPROACHING DETERIORATING WEATHER

TROUGH OF CURVE INDICATES A CHANGE IN WIND DIRECTION

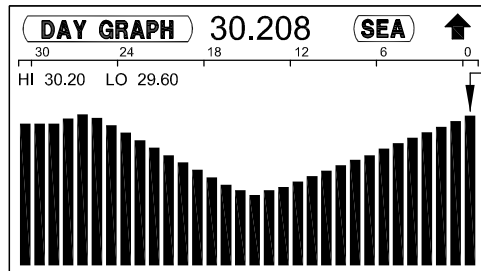

(IMPROVING WEATHER CONDITIONS)

	<b>CURRENT READING</b>
	LOW PRESSURE SYSTEM PASSED 12 HOURS AGO IMPROVING WEATHER

RAPID INCREASE IN PRESSURE FOR LAST 6 HOURS INDICATING CLEAR AND BREEZY

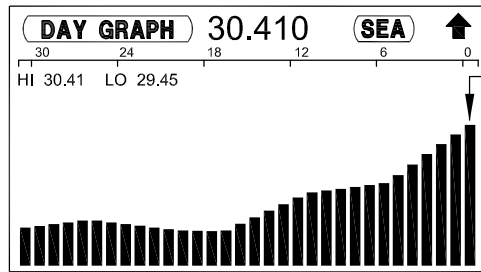

(IMPROVING WEATHER CONDITIONS)

	<b>CURRENT READING</b>
	HIGH PRESSURE BUILDING CLEAR CONDITIONS

CREST OF CURVE INDICATES A CHANGE IN WIND DIRECTION. INCREASING WINDS

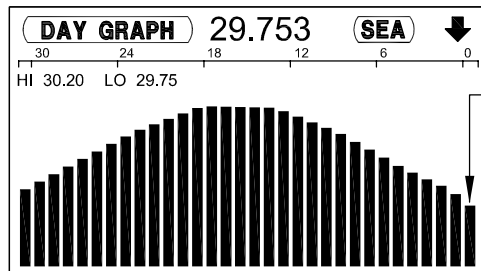

(DETERIORATING WEATHER CONDITIONS)

	<b>CURRENT READING</b>
	HIGH PRESSURE PASSED 12 HOURS AGO. DETERIORATING WEATHER

PRESSURE HAS BEEN STEADY FOR 30 HOURS LIGHT WINDS

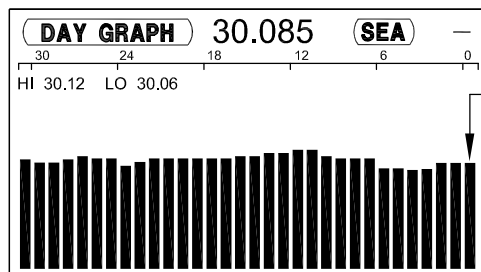

(LITTLE CHANGE IN CURRENT CONDITIONS)

	<b>CURRENT READING</b>
	GRAPH IS FLAT LITTLE CHANGE IN CURRENT CONDITIONS

---

# DBX2 TERMS AND DEFINITIONS

**ACCURACY:** Refers to how far from the true pressure the unit will deviate.

**SENSITIVITY:** Refers to the smallest pressure change the unit can detect.

**RESOLUTION:** Refers to how many decimal places that each format will display.

**LOCAL PRESSURE:** The actual air pressure read by the DBX2, not offset to sea level pressure (relative pressure). Local Pressure is also know as Station Pressure.

**SEA LEVEL PRESSURE:** Local air pressure calculated to sea level pressure. You use the ELEV adjustment to change you sea level pressure.

This allows you to compare your values with other stations around the world. All pressure maps are based on sea level pressure also know as relative pressure. See Page 5 for more information.

**THRESHOLD ALERT:** A user set value that will sound an audible and visual alert when the air pressure drops below that user set value.

**USER PRESSURE:** A user set value that will offset the current local pressure by a specified user amount. Press the MODE button to select USER pressure. This values does not change the SEA or LOCAL pressure only USER.

**CALIBR OFFSET:** A user set value that will offset the units calibration by a specified user amount. It is not recommended that you change this value. It is stored until the unit is reset or power is lost.

**ASL:** Above Sea Level.

**mb / hPa:** Millibars / Hectopascal used outside the U.S.

**inHg:** Inches of mercury. The standard U.S. format.

**mmHg:** Millimeters of mercury. Used in the medical field.

**PSI:** Pounds per square inch

**H2O Ft:** H2O ( feet of water )

**ATM:** Atmosphere

**PAS:** Pascal

**NIST:** National Institute for Standards and Technology.

**FIRMWARE:** The DBX2's upgradable operating system.

## DBX2 ICONS AND SYMBOLS

 = AUDIBLE ALERT IS ON

 = FALLING PRESSURE

 = AUDIBLE ALERT IS OFF

 = FIELD SECTION ARROW

 = RISING PRESSURE

 = THRESHOLD ALERT

 = STEADY PRESSURE

 = SEQUENCE MODE IS SET

# DBX2 SPECIFICATIONS

Barograph Pressure sensor	BOSCH piezo-resistive digital pressure sensor with onboard temperature. High accuracy and linearity as well as long term stability. Pressure range 300-1100 hPa. Fully Calibrated.
Accuracy	Barograph Precision $\pm 0.25$ mb/hPa. and $\pm 0.007$ inHg. for NIST units. NIST testing range is from 860 - 1060mb/hPa
Sensitivity	Barograph Sensitivity 0.100 mb/hPa. and 0.003 inhg.
Resolution	Barograph Resolution 0.01 mb/hPa. and 0.001 inhg.
Pressure format	mb (millibars) hPa or inHg (Inches of mercury). LOCAL and SEA
Altitude	Barograph operates at altitudes up to 12,000 ft / 3658 meters.
Microcontroller	AVR risc processor running @ 16 mhz. 32K Flash memory. Upgradable Firmware. Built in 6 pin "ISP" in system programming.
Barograph Display	128X64 LCD Graphic display with LED backlit. User adjustable contrast control. Backlight ON/OFF control.
Barograph Display Information	Current Pressure, [1] Day high and low pressure, [5] Day high and low pressure, Tendency, Warning messages and rate of rise and fall.
Barograph Display Graphing	1 DAY bargraph and 1 WEEK bargraph.
Barograph Controls	5 BUTTON CONTROL includes LED backlight control, Contrast control. Sound on/off control. Set Threshold Alert and Clear warning message control.
Alerts and Warnings	Audible Barograph alert at 85db with on/off control. Automatic audible alert on large drop detect with warning messages. User settable drop threshold alert. For example, a user could set an audible alert if the pressure falls below 29.60 inhg.
Barograph Power	Includes one A/C power adapter with 9v output and 2.1mm female power jack. Optional 4 AA backup battery backup pack. Up to 14 volts. Power Adapters available for U.K., Europe & Australia. Optional wiring harness.

# DBX2 WIRING HARNESS DIAGRAM

## WIRING INSTRUCTIONS

Important: Always follow your local marine electrical code when wiring your unit.

Turn off the marine craft's electrical system.

Cut wires and slide heat shrink tubes over each wire. Splice and twist wire, matching positive and negative. Turn on marine power and test unit then turn off marine power. Solder wires and heat shrink the tubing in place with a heat gun. Turn on marine power, test unit again, then re-install batteries. Mount unit as desired.

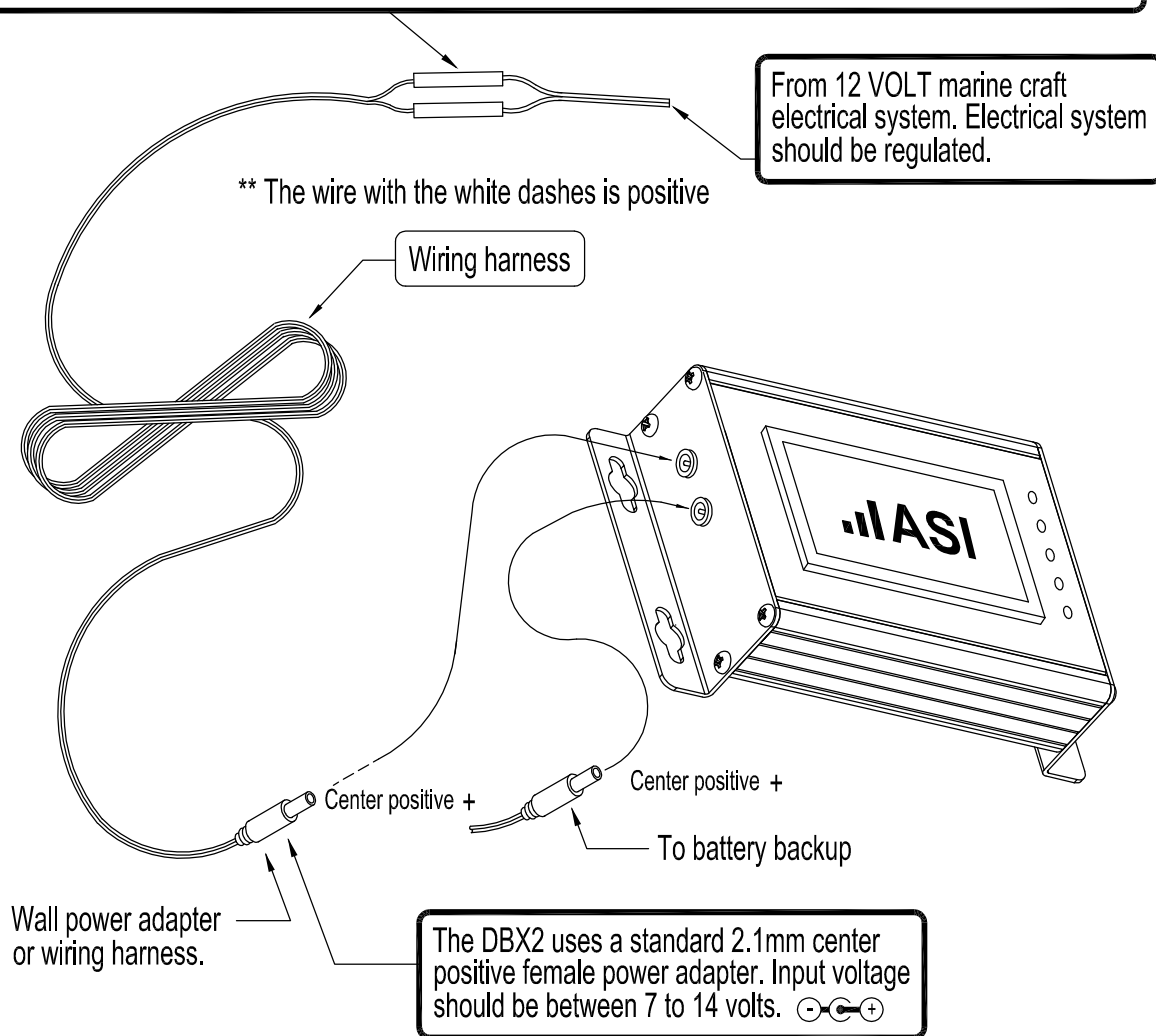

**MAX VOLTAGE: 14 VOLTS**

### NOTES:

The DBX2 unit works directly with 12v Marine craft power systems. The DBX2 can handle external power in the range between 7 to 14 volts. Use a 2.1mm female power adapter to connect to your power system.

### POWER CONSUMPTION:

20.0 mA @ 5.0 volts in standard operation mode.  
160.0 mA @ 5.0 volts in standard operation mode with LED backlight on.

# DBX2 ACCESSORIES

## DBX2 WALL MOUNTING KIT SOLD SEPARATELY

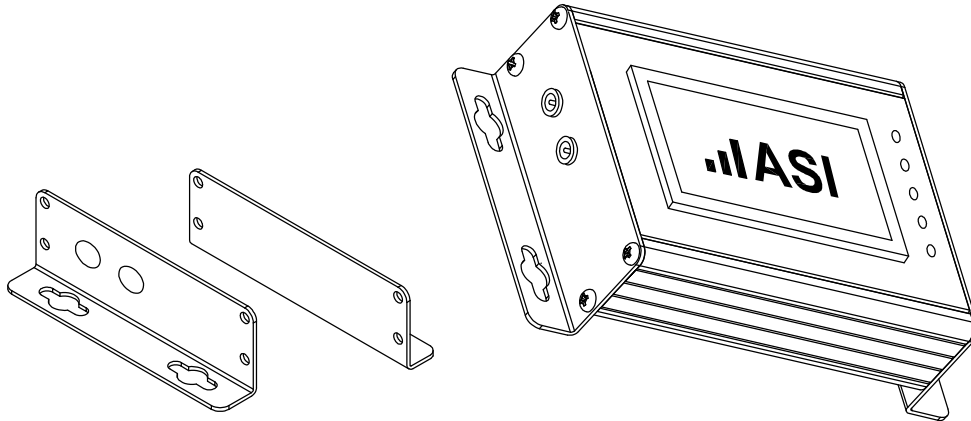

LEFT SIDE BRACKET

RIGHT SIDE BRACKET

WALL MOUNTING OPTION

AC/DC POWER ADAPTER TYPE			
U.S.	U.K.	EUROPEAN	AUSTRALIA

Item No.	Description
P0002	DBX2 WALL MOUNTING KIT INCLUDES 2 BRACKETS
P0003	DBX2 MOBILE 12 VOLT CAR POWER ADAPTER
P0004	DBX2 WIRING HARNESS FOR USE WITH MARINE 12V POWER
P0005	DBX2 US 2.1MM POWER WALL ADAPTER
P0006	DBX2 UK 2.1MM POWER WALL ADAPTER
P0007	DBX2 EURO 2.1MM POWER WALL ADAPTER
P0008	DBX2 AUS 2.1MM POWER WALL ADAPTER

**See Website for latest pricing.**

---

## FREQUENTLY ASKED QUESTIONS

### **WHEN FIRST SET, WHY DOES THE DAY AND WEEK GRAPH ONLY DISPLAY ONE BAR?**

The barograph does not have any data yet. The 1 DAY graph will show a new bar each hour until the whole screen is full. The 1 WEEK graph will show a new bar every 4 hours until the whole screen is full. The right most bar is the current pressure reading.

### **WHAT IS THE MAXIMUM DC INPUT VOLTAGE?**

The unit can handle a maximum of 14.0 volts. It was designed to work with marine power systems.

### **HOW IS THE SYSTEM FIRMWARE UPDATE DONE?**

Send the unit to us and we will update your system firmware and ship it back.

## CARE AND MAINTENANCE

Clean the case with a soft damp cloth. Use a mild water soap solution and dry thoroughly. Clean the LCD screen with a soft damp cloth and let air dry . Use water only. Do not use Windex or cleaning solutions.

There are no user repairable parts. Please contact (ASI) if you need repair.

## DBX2 TROUBLE SHOOTING

Your DBX2 unit should run continuously for months without any issues. Still, there are a few situations that can cause the DBX2 to lock-up or appear to lock-up. Here are the main causes:

1. A fluctuating a/c power supply or a bad wall power adapter.  
(Try cycling your power off and on and see if this resolves your issue)  
Tip: Please make sure that the DBX2 is plugged into a surge suppressor.

CONTACT TECHNICAL SUPPORT IF YOUR PROBLEM PERSISTS.

---

# UNIT TESTING AND CALIBRATION

If you need to have your unit NIST tested and calibrated, please contact us at [support@digitalbarograph.com](mailto:support@digitalbarograph.com). Testing includes a NIST test report, calibration and the latest firmware.

## WARRANTY AND CONTACT INFORMATION

Please see the website for additional information, including (FAQs) Frequently Asked Questions and Adobe PDF documents before contacting technical support.

### **ASI LIMITED WARRANTY:**

1 Year Limited Warranty from date of purchase.

AQUATECH SCIENTIFIC INSTRUMENTS LLC Warrants this unit to be free from defects in materials and workmanship under normal consumer usage for the period outlined.

### **COMPANY INFORMATION:**

AQUATECH SCIENTIFIC INSTRUMENTS LLC  
680 HEACOCK RD SUITE 204A  
YARDLEY PA. 19067

PHONE: 215-428-9400  
FAX: 267-790-0404

### **WEB:**

[www.digitalbarograph.com](http://www.digitalbarograph.com)

### **TECH SUPPORT:**

email: [support@digitalbarograph.com](mailto:support@digitalbarograph.com)

### **SALES:**

email: [sales@digitalbarograph.com](mailto:sales@digitalbarograph.com)

---

# DBX2 DIGITAL BAROGRAPH TO THE XTREME



REV 1.0